

FT-100

TRANSCEIVER

YAESU MUSEN CO., LTD.

TOKYO JAPAN.

INSTRUCTION BOOK
FOR
FT-100 TRANSCEIVER

The model FT-100 SSB Transceiver is a precision built, compact and high performance transceiver with SSB (USB and LSB selectable), CW and AM mode of operation. The transceiver works at an input of 120 watts PEP for SSB and CW, 50 watts for AM on all bands through 80 to 10 meters. All circuits except final and driver stage are transistorized.

The FT-100 is self-contained, requiring only a microphone, a speaker and an antenna for operation in fixed or mobile. The FT-100 is designed for 100/110/200 or 220 volts AC 50/60 cps operation and can be used for DC 12 volts mobile after the installation of DC/DC converter. The selection of AC and DC sources is made automatically with proper line code supplied.

A 100 Kc calibrator is built-in and provision is made for the use of external VOX unit and external linear amplifier such as our FL-1000 linear amplifier.

A specially designed high frequency crystal lattice filter is used for sideband generation. RFA (receiving frequency adjustment) is provided to shift receiver frequency approximately 5 Kc either side of the transmitting frequency. The control may be adjusted to off position to rock the receiver frequency to transmitting frequency. A switch is provided to turn off transmitting tube heater to save battery drain for stand-by period.

Front panel switch selects transmitter to external VFO control for widely different frequency transmission from receiving frequency. The switch also selects 4 prefixed crystal controlled channels with built-in crystal oscillator circuit.

SPECIFICATIONS

Type of emission: USB or LSB (selectable) CW / AM.
Frequency range: 3.5 - 4.0 Mc, 7.0 - 7.5 Mc, 14.0 - 14.5 M
21.0 - 21.5 Mc, 28.5 - 29.0 Mc.
Power input: SSB/CW 120 watts PEP (slightly lower
on 10 meter)
Carrier suppression: 40 db.
Sideband suppression: 40 db.
Distortion products: Down at least 25 db.
Spurious response: Down at least 40 db.
Antenna output impedance: 40 to 100 ohms unbalanced.
Sensitivity: Less than 1 uv for 10 db. S/S+N ratio.
Selectivity: 2.1 Kc at 6 db., 4.5 Kc at 60 db.,
both transmit and receive.
Audio output: 1 watt at 10% distortion.
Power requirement: AC; R 35 watts, T 150 watts.
DC; STBY 1.1 A, R 2.5 A, T 13A.
Dimensions: 153 m/m high, 334 m/m wide, 262 m/m deep.
Weight: Approximately 30 lbs.

CIRCUIT DESCRIPTION

TRANSMIT FUNCTION:

When the push-to-talk switch on the microphone is pressed, the transmitter portion of the transceiver is activated and it generates the transmitting signal in the following manner.

Carrier is generated by two transistors, 2SC37, one of which generates 3,179.4 Kc for USB, AM and CW; the other generates 3,181.4 Kc for LSB, and is applied to the ring balance modulator. Carrier oscillator circuit is selected by the mode switch on front panel for proper frequency and cut off for AM reception. The audio signal from the microphone is amplified through 2SB54 and 2SB94 and applied to the ring balance modulator. Carrier balance is obtained by a potentiometer and trimmer capacitor on the chassis. Double sideband suppressed carrier signal from the ring balance modulator is then passed through the crystal lattice filter which suppresses the unwanted sideband.

The SSB signal from the filter is then amplified through 3,180 Kc IF amplifier stage. The proper amount of carrier is inserted into the base circuit of the 1st IF amplifier stage for CW and AM operation through the mode switch. The 3,180 Kc signal output from T204 is applied to VFO mixer. VFO signal, which is tunable from 8,400 Kc to 8,900 Kc, is also injected into this VFO mixer. This injection voltage is generated by TR402, 2SC372 and isolated from the load by buffer TR401, 2SC372. Tunable IF transformer, T301 connected to the output of VFO mixer, tunes the frequency range 5,720 to 5,220 Kc.

This IF frequency is the result of subtractively mixing the incoming 3,180 Kc signal with the VFO signal. The transformer T301 is gang-tuned with the VFO and thus is always accurately tuned to the frequency to eliminate spurious signals.

The 5,720 Kc to 5,220 Kc signal from the VFO mixer is applied to high-frequency mixer, TR104 2SA296, to which an injection from heterodyne crystal oscillator, TR102 2SC372, is also applied to produce transmitting frequency. The crystal frequency may be 9,220 Kc 12,720 Kc, 19,720 Kc, 26,720 Kc, or 34,220 Kc depending upon the position of the bandswitch and subtractively mixes with incoming signal for final transmitting output frequency. Output from the heterodyne mixer which appears across the coils, L101, or L105, is applied to the grid circuit of driver tube V1, 12BY7 through trap coil which tunes to 5,600 Kc. The output from the driver stage is then coupled to the grid circuit of final linear amplifier tubes 6JM6s. Output coils of the driver stage and heterodyne mixer are gang-tuned by preselector capacitor from front panel. Neutralization of the final linear amplifier is accomplished by feeding back a small amount of the output through TC601 to the bottom of the plate coil of the driver tube. Output power from the final amplifier tube is fed to a pi network to match 50 to 120 ohm load. With antenna relay closed, the output circuit of the pi network is connected to the antenna. The amplified automatic level control circuitry operates in the following manner. When flat-topping occurs in the final amplifier, an audio signal which is proportional to the amount of flat-topping appears to the bias circuit. This signal is coupled to the ALC amplifier transistor 2SB54 whose output is rectified by diodes SH-1. The resulting DC voltage is applied to the DC amplifier TR204, 2SD191 whose output DC voltage which is in direct proportion to the amount of flat-topping in the final amplifier grid circuit controls gain of 3,180 Kc amplifier chain.

RECEIVE FUNCTION:

With the microphone push-to-talk switch released, a signal from the antenna is coupled to antenna coils through antenna relay and trap coil L608 tuned to 5,600 Kc. D106 and D107, across the antenna coil conduct only when extremely strong signals are present and do not otherwise affect the circuit. The signal tuned at antenna coil is coupled to the base circuit of TR101, 2SA239, RF amplifier. The amplified signal from TR101 is applied to heterodyne mixer TR103, 2SA246, and produces 5,720 Kc to 5,220 Kc signal with an injection from the crystal oscillator TR102. The 5,720 to 5,220 Kc signal is then mixed by VFO mixer TR302, 2SA93 to produce 3,180 Kc IF signal with injection from the VFO. The 3,180 Kc signal is applied to 3,180 Kc crystal lattice filter and then amplified through 3 stage IF amplifier chain. Amplified signal is then coupled through T205 to the ring demodulator for SSB and CW detection. The carrier injection to the ring demodulator produces an audio output which is then applied to audio amplifier TR208, 2SB58 through the mode switch.

For AM detection signal is coupled to separate diode detector D201, 1S-1007 from T205. The amplified audio signal is coupled to audio driver TR304, 2SB94 through audio gain control potentiometer on the front panel. The audio signal is then amplified to the speaker level by class B amplifier TR305, and TR306, 2SB200. 3,180 Kc IF signal from final amplifier stage is applied to AM detector/AGC diode D201, 1S1007 which rectifies incoming signal. The resulting DC voltage is applied to AGC/ALC amplifier TR204, 2SD191 whose output DC voltage is supplied to the 3,180 Kc IF amplifier stage and RF amplifier stage to control the gain of the receiver. This control voltage is amplified by S-meter amplifier TR-205, 2SD191 to the level for S-meter reading. The meter is switched by a relay to show final stage IC current or relative power output for transmit. RFA (receiver frequency adjustment) is used to permit slight frequency adjustment in receiver with respect to the transmitting frequency. The control may be turned to OFF position where the receiving frequency is exactly same as the transmitting frequency. The adjustment resistor is factory set so that the VFO frequency on receive is exactly the same as on transmit. Varicap diode connected in series with a small capacitor to the hot end of the VFO coil works to shift the VFO frequency by the voltage applied through the potentiometer. The amount of the shift is adjusted by a potentiometer from front panel by applying DC voltage to the diode. Proper voltage is applied to the diode on transmit to place receive frequency on transmit frequency at approximately center position of the potentiometer.

POWER SUPPLY:

The FT-100 contains a power supply for 100/110/117/200/220, or 234 volts 50 or 60 cps AC operation. A provision is made for easy installation of DC-12 volt DC/DC convertor supplied. After building the DC-DC convertor circuit in the power supply compartment, the necessary connections are made automatically to oper to the supply in either mode (AC or DC) by inserting the proper power code into the receptacle on the rear panel.

INSTALLATION

It is recommended that an excessively warm location be avoided. The transceiver should be placed in a location that provides adequate space around it permitting free air circulation through the cabinet openings. For the fixed operation from AC supply, use an AC code to the receptacle at the rear. The chassis grounding connection that is provided on the rear of the transceiver should be connected to an actual ground by a heavy lead. It is not recommended to use gas or electrical conduit pipes. The grounding lead should be kept as short as possible. Performance both in receiving and transmitting will depend largely on the antenna. Antenna impedance of this transceiver is designed to match 50 to 100 ohm resistive load.

Any antenna designed for use on the amateur bands may be used. If the impedance of transmission line or antenna is far from this value, a suitable antenna tuner must be used between the transceiver and antenna system.

The FT-100 transceiver may be operated in conjunction with any conventional linear amplifier. A plug on the rear panel provides relay contacts for the external linear amplifier and voice control unit.

After installing DC/DC converter in power supply compartment with the parts supplied, the FT-100 will operate from any 12-volt negative ground battery by connecting the DC power cord to the rear-panel receptacle. When making connections to the car battery, be sure to connect red lead to the positive(+) terminal and black lead to the negative terminal(-). Reversed connection could permanently damage the transistors and diodes used. 15 amp fuse must be used between the transceiver and battery supply.

Prior to operating the FT-100 in mobil, the voltage regulator of the car must be checked to make certain that the voltage, when charging does not exceed 14.6 volts to avoid permanent damage of the FT-100.

On the higher frequency bands, the noise generated by the ignition system, or generator will cause poor reception of weak signal. Noise reduction information given in amateur literature will be helpful.

IMPORTANT

Do not operate FT-100 transceiver before familiarizing yourself completely with this instruction book because improper adjustment of the controls may result in signals of poor quality.

FUNCTION OF CONTROLS

POWER:

The power ON/OFF switch is located at the left of the front panel. Pressing upper side of the switch turns the unit on. Since receiver portion is entirely transistorized, no warm-up period is required.

TUNING DIAL:

The large knob at center of the front panel controls operating frequency. The dial consists of two dials, main dial in the dial window and 50 divisions subdial on the knob.

The main dial has two calibrated scales which are colored red and black to match the color of the band switch. The scales are 10 Kc per division. The subdial on the tuning knob is divided in 50 divisions, and 1 division is approximately equal to 1 Kc.

MIC:

Microphone jack has three poles, i.e., microphone input, push-to-talk and ground connection. Refer to the illustration for mic plug connections.

MODE:

This switch is used to select the mode of operation. Sideband is selected by removing the DC supply from the carrier oscillator which is not used. On CW position, USB oscillator works, microphone amplifier is inoperative. Carrier is inserted into the base circuit of 1st IF amplifier through small capacitor. On AM position, USB oscillator works for only transmit and the carrier is inserted in the manner described above. Separate detector for AM and SSB/CW is also selected by the mode switch.

AF/RF GAIN:

Double shaft potentiometer is used to control RF and AF gain of the receiver. Large knob controls RF gain potentiometer, and small knob controls audio gain potentiometer.

BAND:

This control is used to select the amateur band desired.

BAND	FREQUENCY RANGE
80	3,500 to 4,000 Kc.
40	7,000 to 7,500 Kc.
20	14,000 to 14,500 Kc.
15	21,000 to 21,500 Kc.
10	28,500 to 29,000 Kc.

RFA:

This knob is used to shift receiving frequency approximately 5 Kc either side of the transmitting frequency; thus, it is possible to set the receiver to the most easy listening point without affecting transmitting frequency. At OFF position, your transmitting frequency is exactly the receiving frequency.

SELECT:

This switch selects VFO signal. At **NOR.** position, main tuning knob is used to control operating frequency both for transmit and receive.

At EXT position, an external VFO can be used for transmitting only for widely separate frequency transmitting from the receiving frequency. At C1 1 to 4 positions, crystal oscillator circuit is connected instead of VFO. 4 pretuned channel operation is possible within amateur bands. Its use is particularly valuable in "Scheduled Contact".

Relation between VFO frequency and operating frequency is as follows.

VFO DIAL	0	100	200	300	400	500	
KC	500	600	700	800	900	0	
FREQUENCY							
KC	8,900	8,800	8,700	8,600	8,500	8,400	VFO
	5.72	5.62	5.52	5.42	5.32	5.22	ZF

CALIB:

This switch controls the 100 Kc built-in crystal calibrator. Pressing the switch up to the ON position inserts a beat signal every 100 Kc on all bands.

METER SWITCH:

Meter is selected to measure the total cathode current of final tubes at IC position and relative power output at PO position. For receiving, the meter works as S-meter automatically.

HEATER:

This switch turns off the transmitter tube heater to save battery drain for long period of listening. Pressing switch up to ON position supplies heater voltage. After 30 second of warm-up period, the transmitter is ready to transmit.

PA TUNE & LOADING:

These controls are used to tune the final pi output network. approximate setting of PA tune is indicated on the panel.

PRESELECTOR:

This control is used to tune the front end for receiving, and driver stage for transmitting.

TRANSMITTER TUNEUP:

Turn on the power switch and allow 30 seconds for warm-up of the transmitter tubes. Set the band switch to the desired band. Tune the preselector for maximum receiver noise. Set the mode switch to AM mode and press the push-to-talk switch on the microphone.

Tune the preselector for maximum IC reading. Tune the PA TUNE for sharp dip in meter indication. At this point set the meter switch to OP position and tune the LOAD control for maximum meter reading. Repeat alternating adjustments of the PA TUNE and LOAD controls until the meter reads maximum output. For AM operation, adjust drive control on the rear panel until tuned plate current IC shows 100 milliamperes, for SSB and CW operation, set the drive control fully clockwise for maximum output.

Mic gain control is on the bottom of chassis and can be adjusted with screw driver from the opening in the bottom of the cabinet. This gain control is adjusted at the factory for proper operation with dynamic microphone. It is very important to set the mic gain at proper position. If it is too high, excessive distortion and splatter will be produced. On the other hand, too low setting will result in low transmitter output.

TROUBLE SHOOTING AND ALIGNMENT

The FT-100 transceiver has been carefully aligned and tested with proper equipment at the factory, however some difficulty may possibly arise from the effects of vibration and temperature changes during use and their detection and correction must be done after the operation of transceiver is fully understood.

DANGER!!

High voltage is present in the equipment whenever the transceiver is turned on. High voltage also remains in filter capacitor after the unit is turned off, therefore make sure there is no high voltage in the circuit before making internal adjustments.

Low transmitter output generally indicates weak tubes. If the off-resonance plate current of the final tube at maximum drive becomes less than 200 ma, as indicated on the front panel meter (meter switch IC position), either the driver or final tubes may require replacement.

The receiver portion of the transceiver is fully transistorized, therefore the sensitivity should not diminish with age except for a slight drift in tuning circuit. In this case, the RF trimmer and slugs may require adjustment.

CHASSIS REMOVAL FROM THE CABINET:

Remove the four screws on the bottom of the cabinet and carefully slide the chassis and panel assembly out from the back of the cabinet.

TEST EQUIPMENT REQUIRED:

Recommended service equipment for alignment or trouble shooting is:

- A. Sensitive VTVM with a RF probe.
- B. Signal generator covering 3 to 35 mc.
- C. Calibrated communication receiver.
- D. Oscilloscope.
- E. Audio oscillator.
- F. Dummy load.

Note: Care must be taken to avoid permanent damage to transistors which is usually caused by an accidental short.

CARRIER BALANCE:

Connect a VTVM RF probe to the center arm of the carrier balance potentiometer. A reading of 1 volt RMS or more indicates correct performance of the carrier oscillator circuit.

Tune the transceiver up on any band in SSB mode. Connect VTVM with RF probe to antenna terminal. Adjust the carrier balance potentiometer and trimmer capacitor on the chassis alternatively for minimum indication of VTVM. Repeat this procedures for USB and LSB. Some compromise for both sidebands may be required since there may be a slight difference in carrier balance between two modes.

USB 3172540 Hz LSB 3181660 Hz

Note: Carrier frequency adjustment in the carrier oscillator compartment can also affect carrier balance, however care must be paid to place the carrier on the notch of the filter.

VFO:

Trimmer (Lage), frequency

Faulty VFO operation is indicated when no receiver operation is obtained on any band. A reading of 0.2 - 0.3 volts approximately is normal on VTVM connected to the output coaxial cable in VFO box. Adjust the VFO buffer coil for peak at the center of the VFO frequency. To adjust VFO frequency, set the RFA control to OFF, tune the transceiver to a signal of the built-in 100 Kc calibrator and adjust the VFO trimmer until the signal is Zero beat at the correct dial reading.

HETERODYNE OSCILLATOR:

Connect the VTVM to the output coaxial cable from oscillator section. Set the band switch to 10 meters. Adjust L112 for maximum VTVM reading. A reading of approximately 0.2 volts is normal operation for the oscillator. Now set the bandswitch to 15 meters and adjust appropriate ceramic trimmer for reading of 0.2 volts. In this way, adjust all trimmers for appropriate band for 20, 40 and 80 meters.

T201: (T202)

Connect a dummy load to the antenna terminal and tune the transmitter on 3.8 Mc. Connect the two-tone signal generator into the microphone jack and with the microphone button pressed, tune the transmitter controls for maximum power output. Then reduce the input of two-tone signal to avoid saturation and adjust T201 for maximum output.

T203 and T204:

With the condition described above, adjust the slugs of both transformer for maximum output.

T301:

Set the VFO to (0 position), and adjust slugs of T201, for maximum output. Set the VFO to (500 Kc position) and adjust TC-402 and TC-403 for maximum output. Repeat this procedure until tracking is accomplished.

T205:

Tune the receiver to incoming signal or 100 Kc calibrator signal and adjust slug for maximum S-meter reading. Adjust RF gain control for proper reading of S-meter to avoid saturation.

HETERODYNE MIXER & DRIVER:

Set the transceiver to transmit at 28.75 Mc with AM mode and adjust the transmitter controls for maximum output. Set the preselector control knob at center and adjust slug of L101 and L114 for maximum output. Adjust slugs of L102, L103, L104 and L105, L115, L116, L117 and L112 on appropriate setting of the band switch with the method above described.

RECEIVER RF AMPLIFIER:

Set the receiver to 28.75 Mc, with AM mode and connect a signal generator to the antenna connector and set for operation at 28.75 Mc unmodulated. Reduce the attenuator of the signal generator to read S6 on S-meter. Set preselector control at center. Adjust L107 for maximum S-meter reading. Adjust L108-L112 on appropriate setting of the band switch with the method above described. Finally set the transceiver to transmit and adjust controls for maximum output, then release microphone push button and see that maximum receiver noise occurs at the same setting of the preselector control. If not, adjust slugs of appropriate band very slightly until the two settings are nearly the same.

L106: L608

Adjustment of this coil reduces the spurious radiation of IF signal on 40 meter band. Tune the transceiver to 7,250 Kc and tune.

VOLTAGE CHART

		Emitter	Base	Collector
TR101	RF Amp.	4.6V	4V	0.3V
102	Heterodyne OSC.	0.6	0.6	8.2
103	" REC.	12	11.5	0.2
104	" TRANS.	10	9.5	0.4
TR201	IF Amp.	11.8	11.1	0.4
202	"	11.5	11.1	0
203	"	11.6	11.1	0
204	AGC Amp.	0	0.2	0.1
205	S-meter	0.1	0.1	12.5
206	Carrier OSC USB	1.7	0.4	8.2
207	" LSB	2.1	0.1	8.2
208	REC Audio Amp.	9.9	8.7	2.4
TR301	100 KC Calibrator	1.1	0.2	12.1
302	REC VFO Mixer	11.5	11	0.2
303	TRANS VFO Mixer	10.5	9.9	0.2
304	REC Audio Driver	9.4	7.5	0.5
305	REC output	12.7	12.4	0
306	" "	12.7	12.4	0
307	MIC Amp.	6	4.3	1.8
308	" " "	7.2	4.2	1.8
TR401	VFO OSC.	1.6	2	5.9
402	VFO Buffer.	0.7	1.1	7.7
TR501	FIX CHANNEL OSC.	0.8	0.6	8.4

PIN NO.	1	2	3	4	5	6	7	8	9	10	11	12
12BY7A (REC)	0	-150V	0	12VAC	0	-270V	200	0				
(TRANS)	2.5V	0	0	12VAC	0	-		0				
6JM6 (REC)	12VAC	-	165V		-150V	-	-	-	0	-		PLATE
(TRANS)	12VAC	-	150V	0	-30V	-	-	-	0	-		540
												500

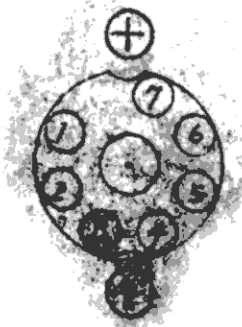

VOX & EXT AMP CONNECTION.

1. GROUND.
2. +12V DC.
3. TO RELAY OF VOX UNIT, CLOSE TO GROUND
4. AUDIO FOR VOX AMP. FOR TRANSMIT.
5. CLOSE AT RECEIVE.
6. RELAY COMMON.
7. CLOSE AT TRANSMIT.

CHASSIS TOP VIEW

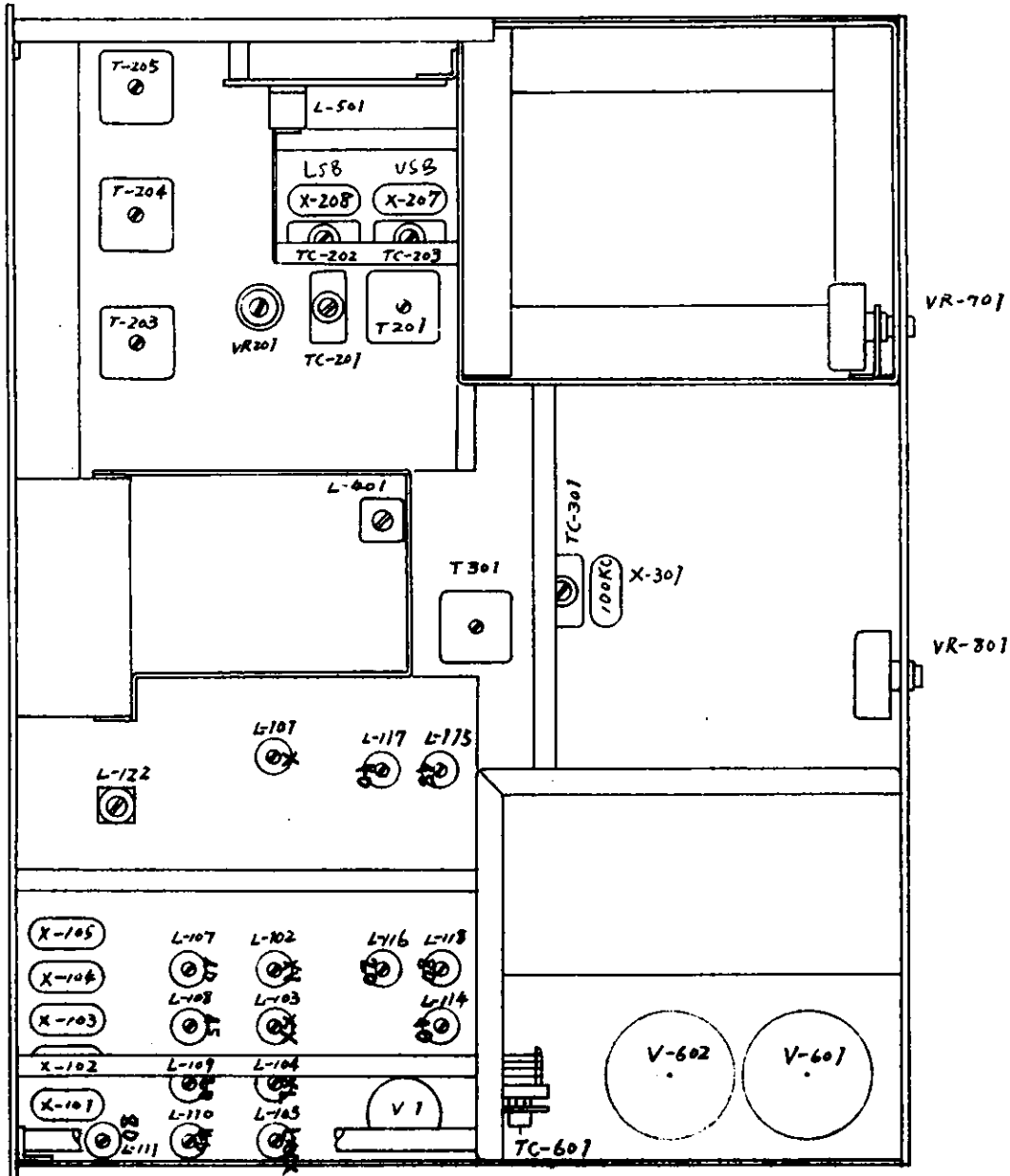

CHASSIS BOTTOM VIEW

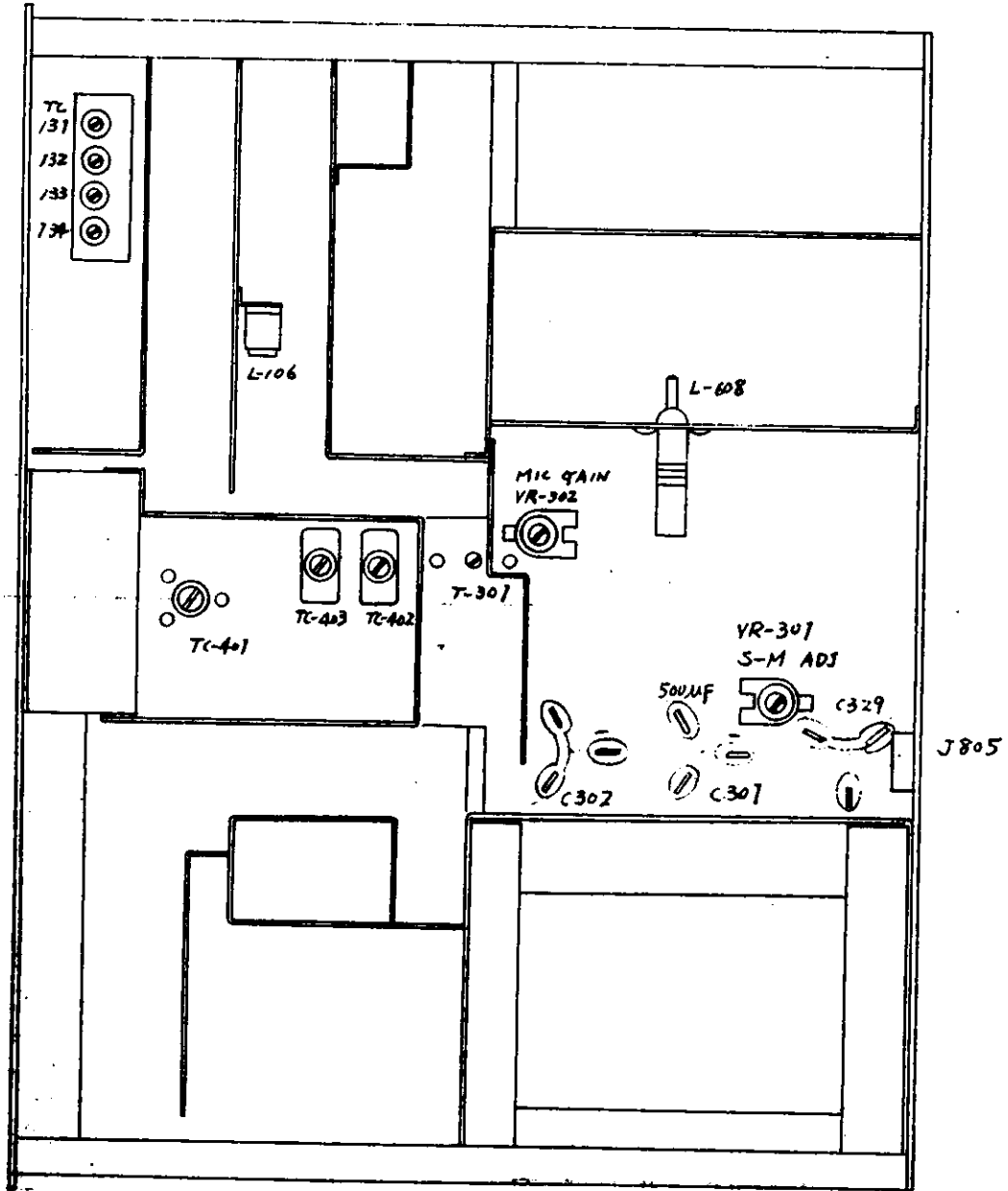

BLOCK DIAGRAM FOR FT-100

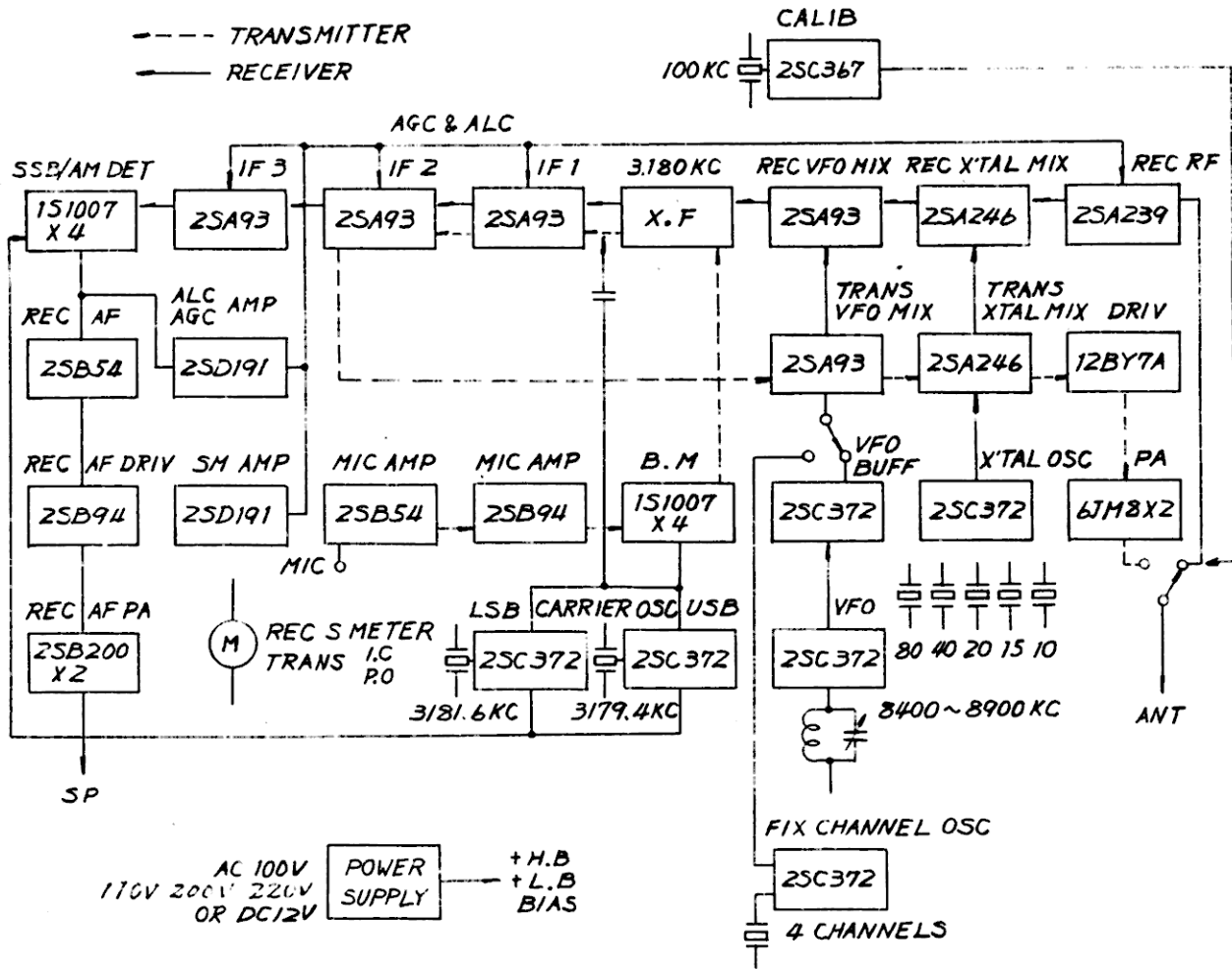

PLUG CONNECTIONS

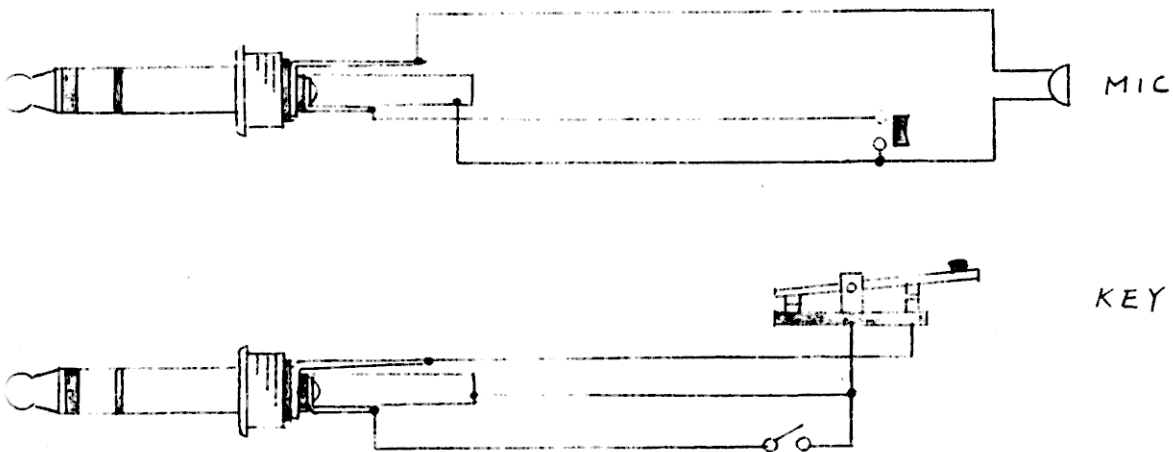

XO Frequency

80m	9220 kHz
40m	12720 kHz
20m	14720 kHz
15m	26720 kHz
10m	34220 kHz

{ IF 5720 kHz - 5220 kHz }
{ VFO 8900 kHz - 8400 kHz }

Skala 0 — 500

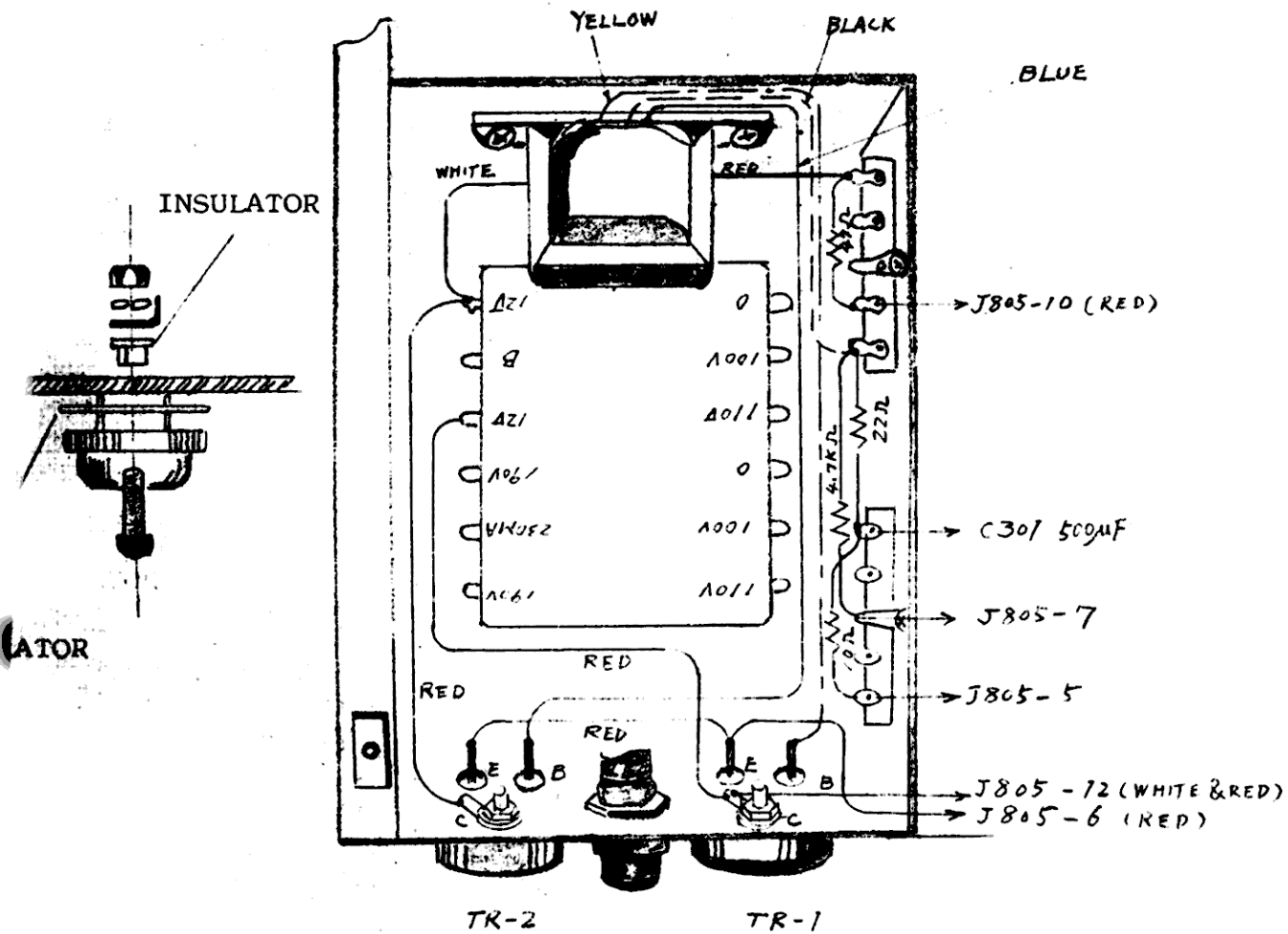

TR-1	TR-2	ZSB212	2
OSC TRANS.			1
		47Ω 6W	1
		4.7K 2W	1
		22Ω 2W	1
		10Ω 1W	1

INSTALLATION OF DC/DC CONVERTOR CIRCUIT

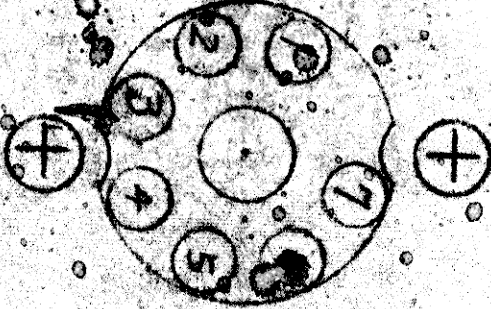

VOX & EXT AMP CONNECTION.

1. GROUND.
2. +12V DC.
3. NO RELAY OF VOX UNIT, CLOSE TO GROUND FOR TRANSMIT.
4. AUDIO FOR VOX AMP.
5. CLOSE AT RECEIVE.
6. RELAY COMMON.
7. CLOSE AT TRANSMIT.

2. Empf. Misches

1. Empf. Misches

Empf.
Sende

Instbr.
Mensch.

VFO
Mensch.

Gittervomp.

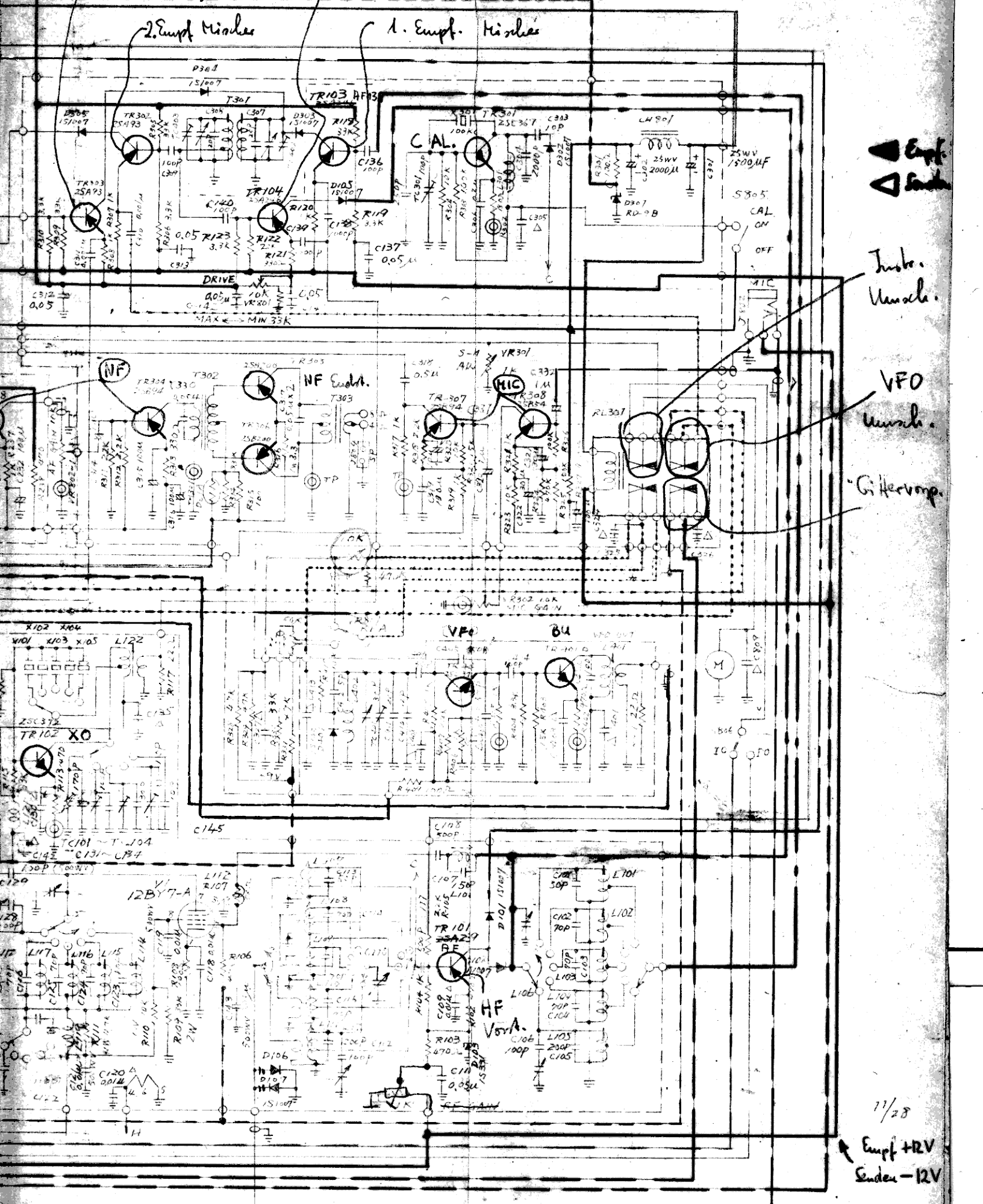

11/28

Empf +RV
Sende -12V